

I
NI
ADINI
BARDIN
LOMBARDI
LOMBARDI
LOMBARDINI
LOMBARDINI

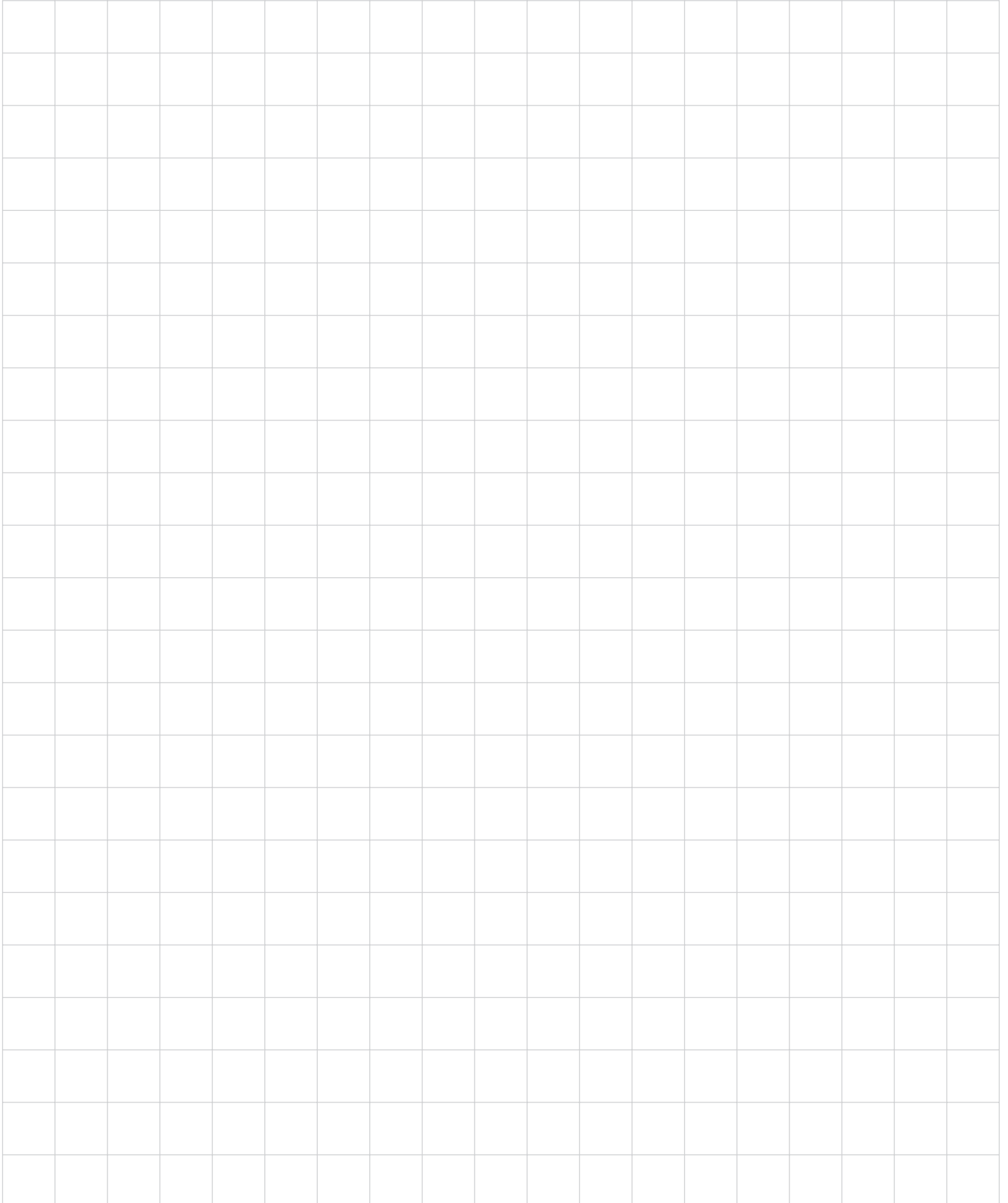

L'esperienza di dare forma alle idee.
Experience in shaping ideas.

Custom



Plasmare la materia per dare vita a nuove forme

Lombardini Srl dal 1955 a oggi ha estruso 175.908.000 metri di profili in oltre 158 colori in 3.572 sagome diverse rispondendo alle specifiche esigenze dei suoi clienti.

Grazie alla continua e costante spinta all'innovazione che da sempre anima l'attività dell'azienda, Lombardini Srl è in grado di realizzare profili monoestrusi, co-estrusi e triestrusi, con i più noti materiali termoplastici oggi presenti sul mercato.

Moulding new shapes

Since 1955 Lombardini Srl has been extruding 175.908.000 meters of profiles with over 158 colours and 3.572 different shapes to meet any specific requirement.

Thanks to an uninterrupted strive for innovation that has always supported the company's business, Lombardini Srl can manufacture mono-extruded, co-extruded and tri-extruded profiles, using the most common thermoplastic materials available.

La gamma di prodotti si divide in - The product range includes

biflex®

*coestrusi e triestrusi
co- and tri-extruded profiles*

sigilgomma®

*monoestrusi e coestrusi
in gomma termoplastica
thermoplastic rubber
mono- and co-extruded profiles*

sigilplast®

*monoestrusi flessibili
flexible mono-extruded profiles*

tecnopro®

*monoestrusi e coestrusi rigidi
rigid mono- and co-extruded profiles*

TEC-NPR®

*stampati a iniezione
injection molded*

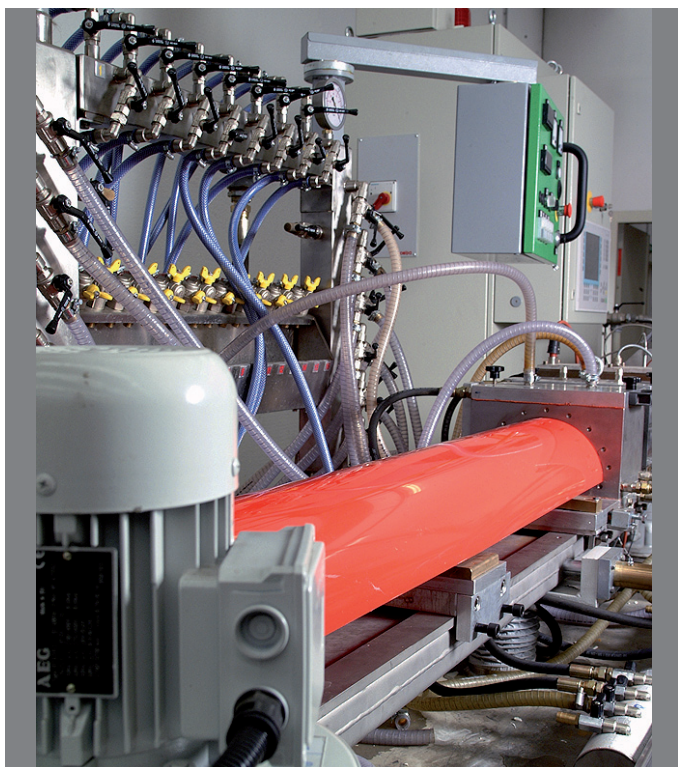



Profili su misura al 100%

L'ufficio tecnico di Lombardini Srl, interpretando le richieste del cliente, studia la fattibilità, suggerisce eventuali modifiche e realizza il disegno esecutivo dell'attrezzatura. L'officina meccanica interna costruisce la filiera e il relativo calibro di raffreddamento per la corretta estrusione del profilo richiesto. Il profilo estruso può essere ulteriormente personalizzato attraverso trattamenti superficiali quali foratura, tranciatura a passo, biadesivizzazione e confezionamento in kit. Il processo produttivo di Lombardini Srl è certificato **ISO 9001-2008**.

100% customised profiles

*Meeting customers' requests the technical department at Lombardini Srl analyzes the application, suggests possible changes and designs the equipment. The in-house workshop manufactures the tools and the corresponding cooling gauge to correctly extrude the required item. The extruded profile can be further customised with surface processing such as drilling, step blanking, double adhesivation and kit packaging. The manufacturing process of Lombardini Srl has been awarded the **ISO 9001-2008** certification.*

La linea di prodotti Custom comprende *The Custom line includes profiles for*











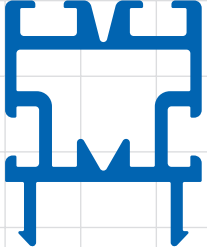

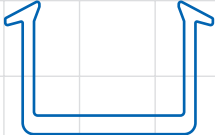















- **Profili per serramenti in alluminio**
Profiles for aluminium doors and windows
- **Profili per serramenti in legno**
Profiles for wood doors and windows
- **Profili per mobili**
Profiles for furniture
- **Profili per applicazioni industriali**
Profiles for industrial applications
- **Profili porta prezzi**
Profiles for price holders
- **Profili per edilizia**
Profiles for building industry
- **Tubi e tondi rigidi e flessibili**
Rigid and flexible tubes and rods
- **Profili per nautica**
Profile for nautic systems

31/922

Profili per serramenti in alluminio

Profiles for aluminium doors and windows

flessibile - flexible rigido - rigid

















R 490	R 539	R 784	S 1881	S 2006	
					
S 2074	S 2112	S 2118	SG 034	SG 054	SG 064
					
SGX 001	SGX 010	SGX 017	SGX 041	SB 1056	
					
SB 353	SB 376	SB 411	SB 537	SB 593	
					
SB 613	SB 620	SB 641	SB 780	SB 792	
					
SB 818	SB 824	SB 846	SB 965	SB 983	
					

16/66

Profili per serramenti in legno

Profiles for wood doors and windows

flessibile - flexible rigido - rigid









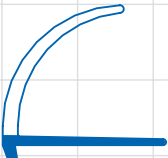

R 117	R 689	SB 561	SB 720	SB 724	
					
SB 728	SB 751	S 1818	S 2133	S 2081	
					
SG 017	SG 030	SG 032	SGX 049	SB 845	SB 960
					

31/427

Profili per mobili

Profiles for furniture

flessibile - flexible rigido - rigid

SB 428	SB 429	SB 448	SB 444	SB 449
				
SB 446	SB 567			
				
SB 472	SB 484	SB 494	SB 737	SB 736
				

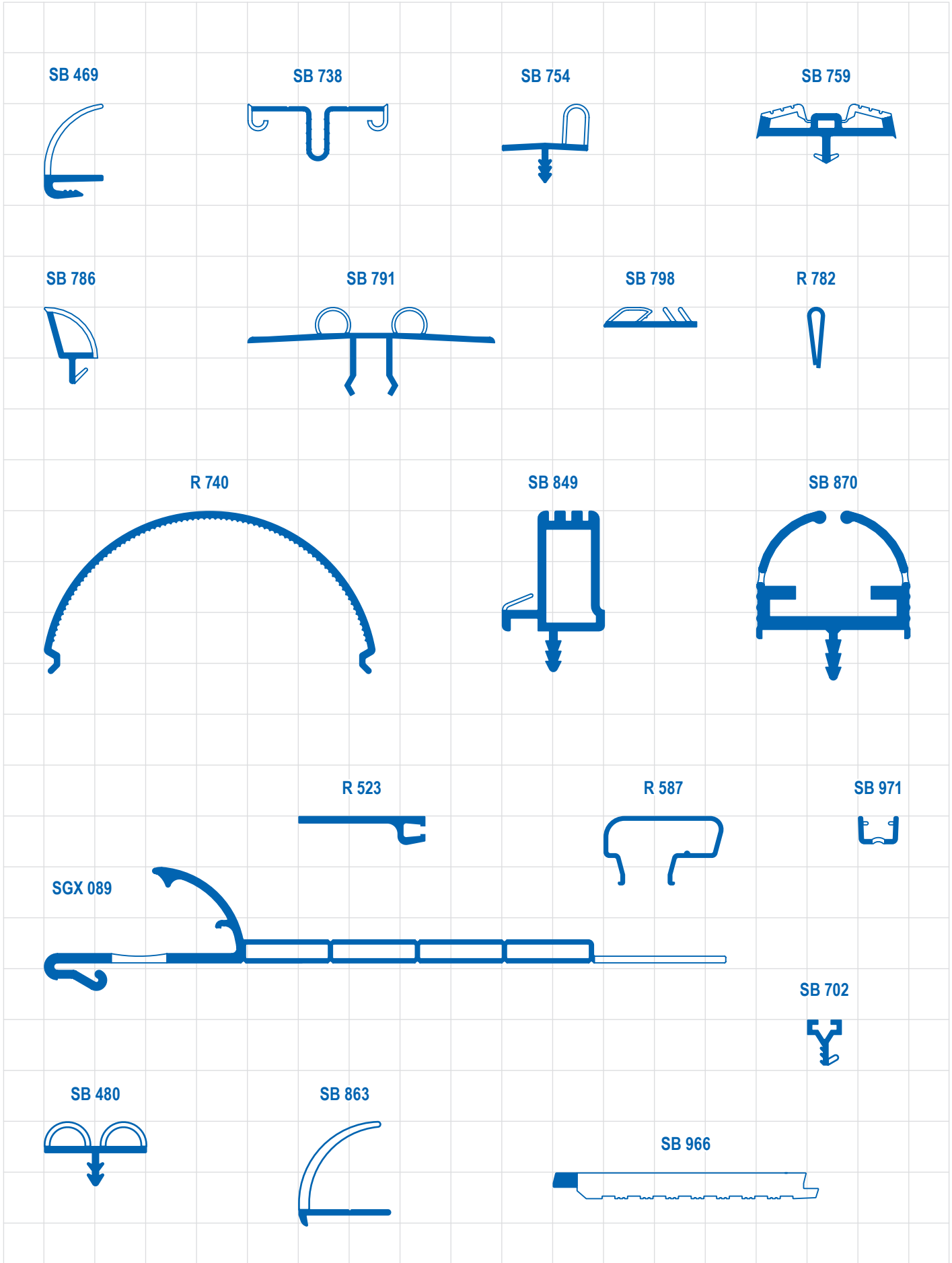

13/
1339

Profili per applicazioni industriali

Profiles for industrial applications

flessibile - flexible rigido - rigid

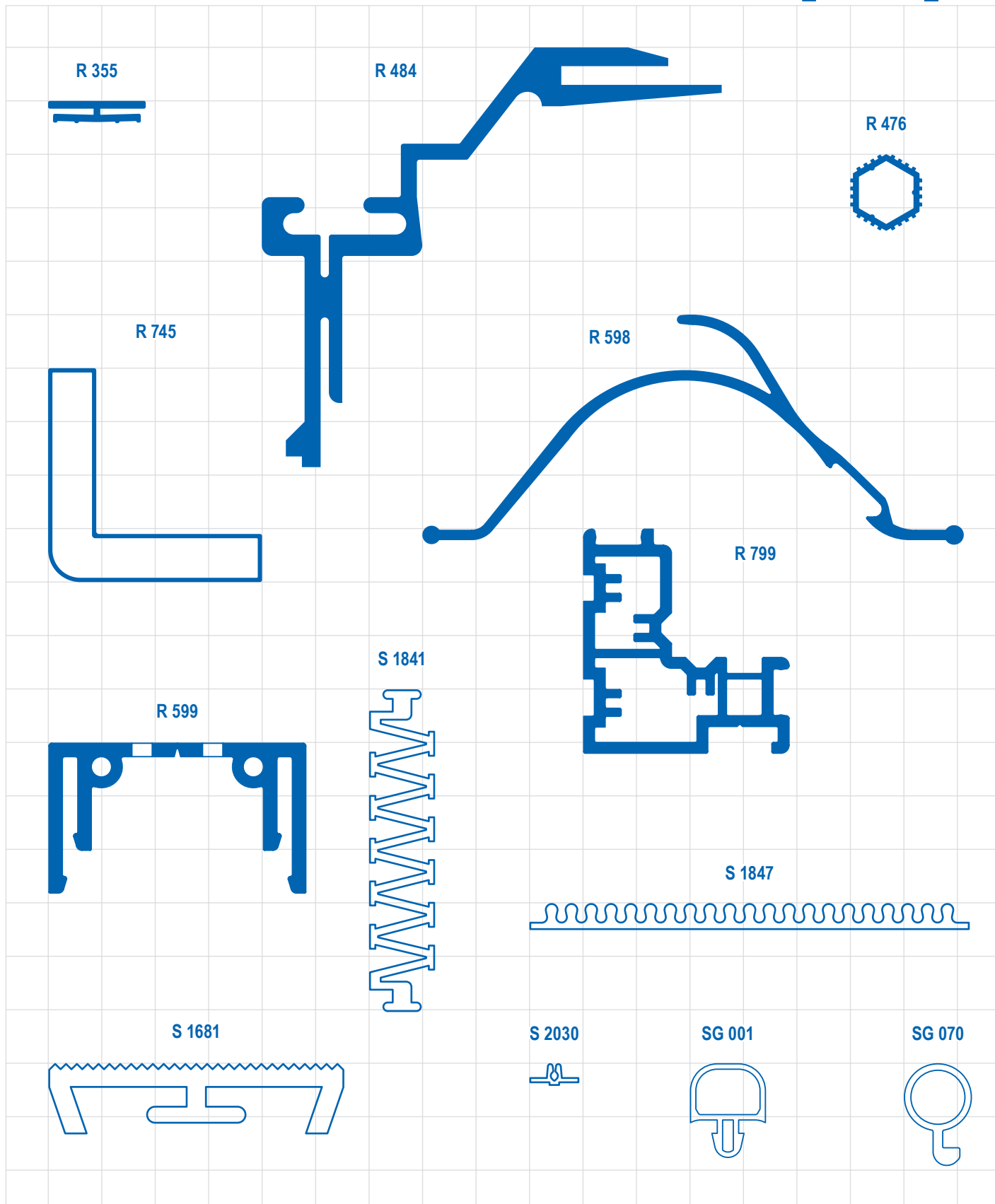

6/66

Profili porta prezzi *Profiles for price holders*

flessibile - flexible rigido - rigid

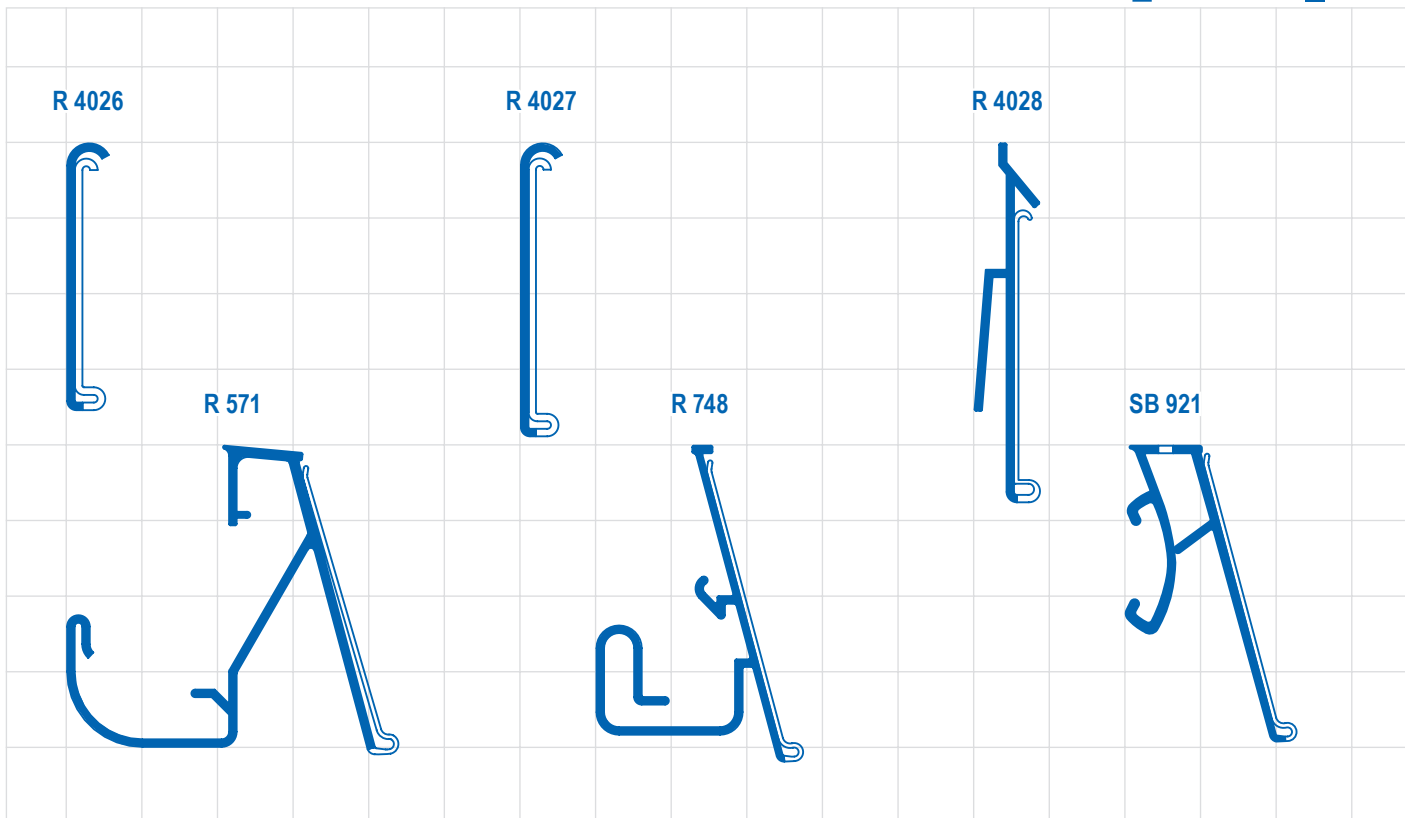

6/585

Profili per edilizia *Profiles for building industry*

flessibile - flexible rigido - rigid

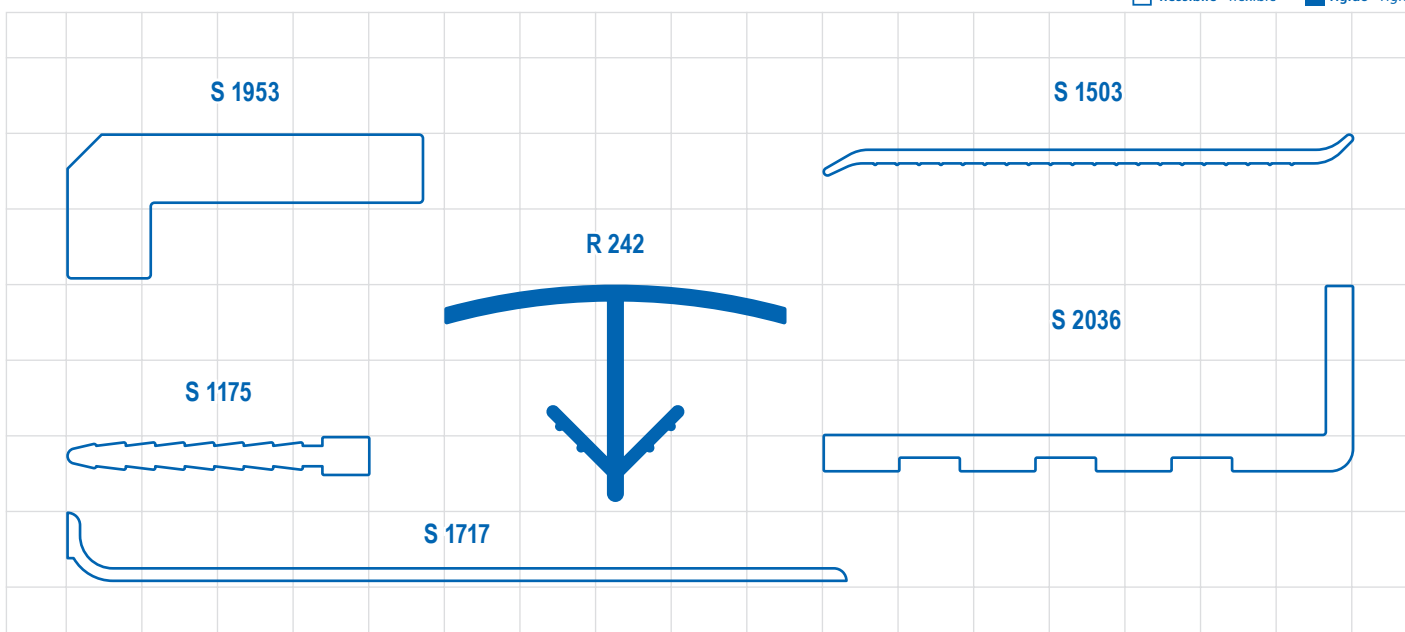

8/94

Tubi e tondi rigidi e flessibili

Rigid and flexible tubes and rods

flessibile - flexible rigido - rigid

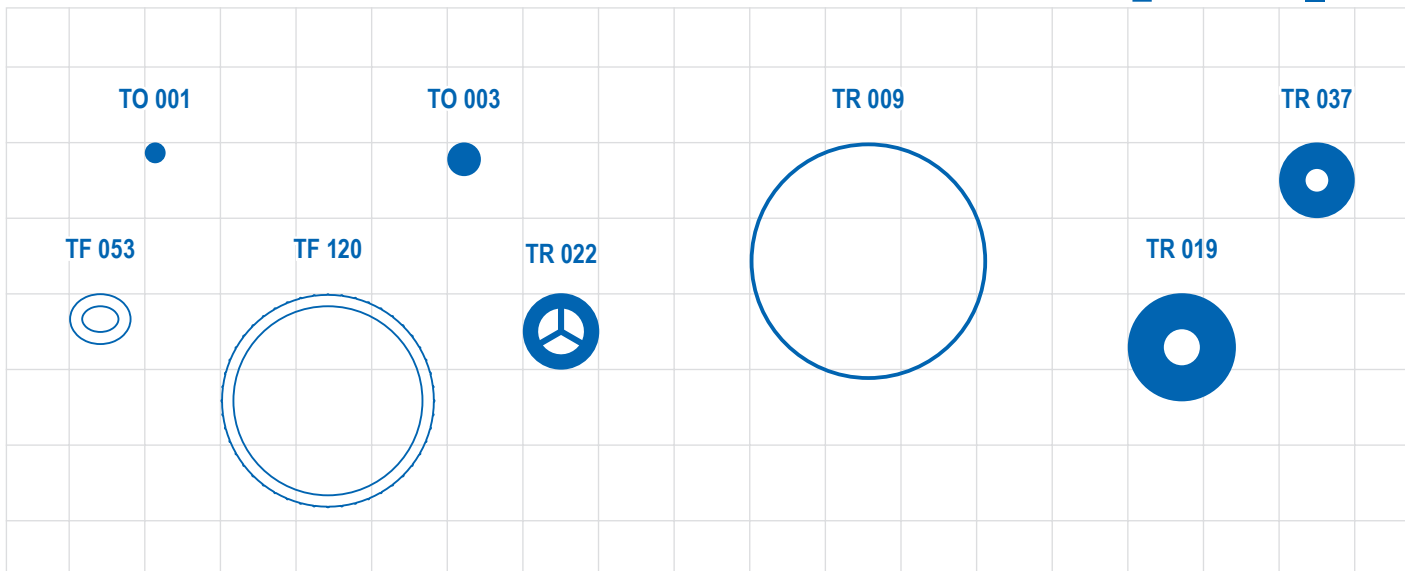

13/47

Profili per nautica

Profile for nautic systems

Lombardini Srl realizza inoltre profili, guarnizioni ed accessori per il settore della nautica. L'esperienza cinquantennale dei nostri tecnici consente di produrre un'affidabile gamma di prodotti realizzati utilizzando materie prime esclusive.

Moreover, Lombardini Srl manufactures profiles, gaskets and accessories for nautic system. Our engineers boast more than 50 years of expertise and can provide a reliable range of products based on exclusive raw materials.

flessibile - flexible rigido - rigid

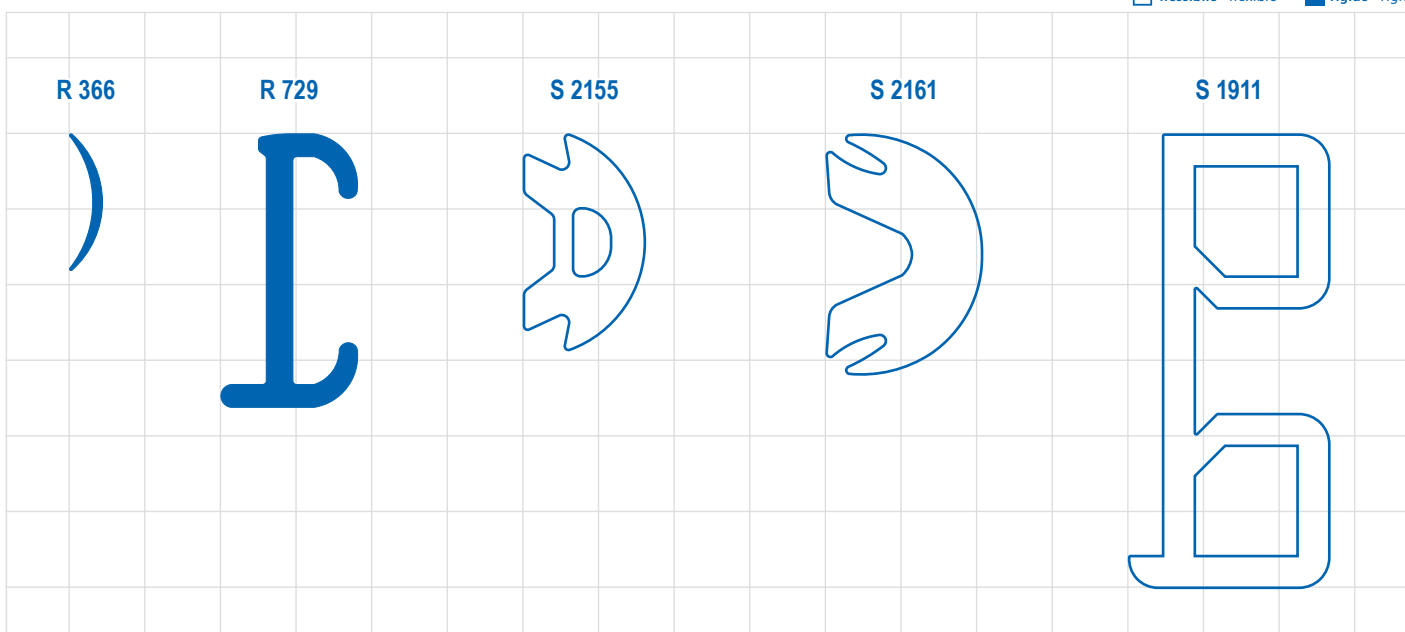

R 698

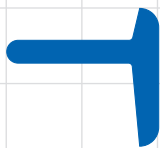

S 2142

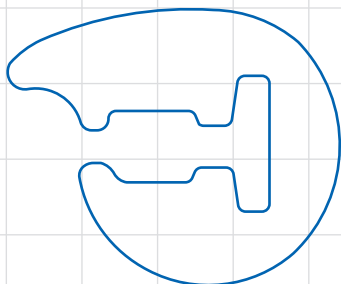

S 1931

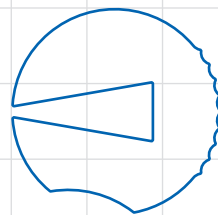

S 2148

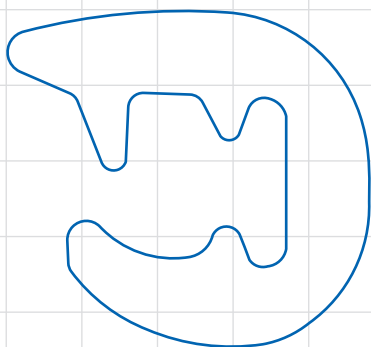

SB 936

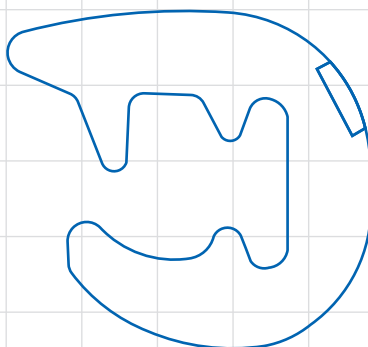

S 1930



S 2096

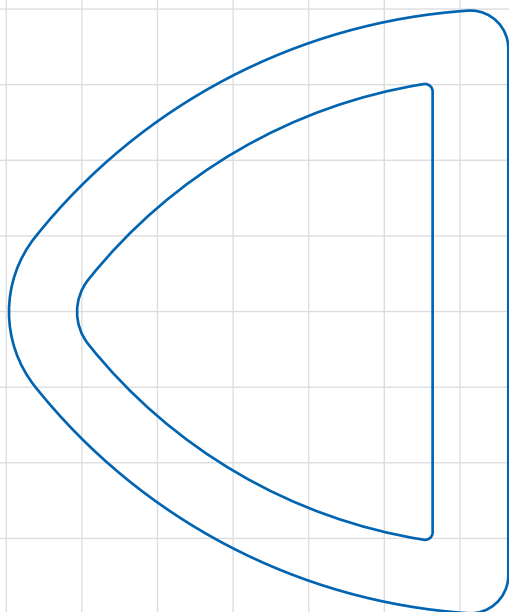

S 2117

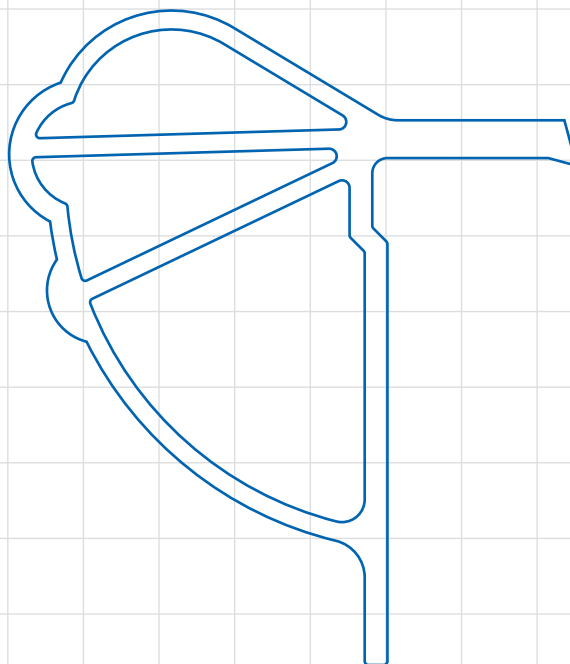

Lombardini Srl

Via Simone da Corbetta, 158 - 20011 Corbetta (MI) - Italy

Tel.+39 02 97 21 851 - Fax +39 02 97 27 23 22

vendite@lombardinisrl.com - estero@lombardinisrl.com

www.lombardinisrl.com

